



**ROLLER DOORS
A & AA**

All roads lead to



STEEL-LINE

GARAGE DOORS

All roads lead to



STEEL-LINE GARAGE DOORS



The most prominent feature of your home can often be the garage door, so it makes sense to not only choose a door for its strength and security but for its aesthetic appeal.

Steel-Line's range of doors brings this decision down to only one.

Which of the Steel-Line products to choose?

Our range of Roller Doors are constructed from the finest materials available to give your home the appearance it deserves.

For years now the Steel-Line range of doors has set the industry benchmark for Style and Quality.

The exclusive Steel-Line door curtain is a unique roll formed profile engineer designed for superior strength whilst maintaining a unique appearance sure to enhance your home. Roll formed from genuine BHP Colorbond® or Zinalume® steel.



All Steel-Line doors revolve on precision made nylon drum wheels, the latest in door technology. The door is counter balanced using helical springs to ensure perfect balance and operation. All our springs are heat treated and stress relieved prior to assembly to give years of trouble free operation.

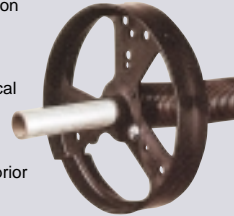

Our lock is a stylish slim-line centre lock generally mounted waist high, lockable by key from the outside and features an internal keyless manual over ride that is Total Security.



For high wind areas ask us about our optional Windlok System.

Roller Doors



Slotted Curtain Roller Door



Exterior or Reverse Roller Door Application

The Steel-Line door incorporates a nylon felt webbing and unlike some doors is fixed to both sides of the door curtain. This eliminates any metal on metal contact giving an extremely quiet and smooth operation for years to come.



Installation

The Steel-Line Series "A" and "AA" door overlaps the rear of the opening and can be fixed direct to the brickwork. Sufficient side room is required on both sides to allow installation of guides and brackets (75 – 100mm). Building piers or posts should be kept flush with inside of the lintel to provide fixing for the support brackets.

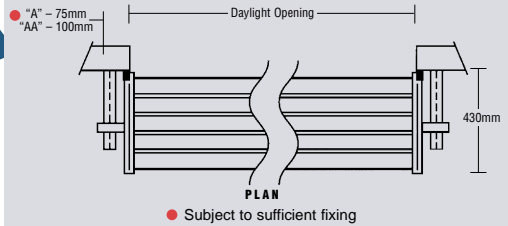
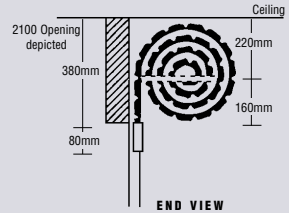

A heavy duty extruded aluminium bottom rail engineer designed to strengthen the bottom panel of the door which incorporates a specially designed weather seal extruded from tough durable PVC.

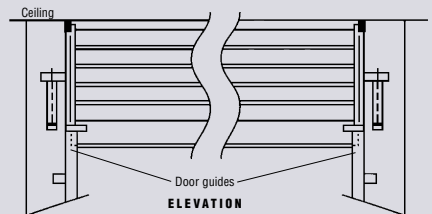

IDA
International Door Association
Develop and Promote Door Quality Excellence

STEEL-LINE

HIGH WIND WARNING



Steel-Line Windlok by Creeks Secures and Protects Roller Doors Even in Cyclonic Conditions

UNIQUE PATENTED DESIGN

Unique design, greater strength

Great strength and rigidity are qualities of the unique design of the Steel-Line Windlok System for Roller Doors used in high wind locations.

The patented system, developed by Creeks Metal Industries, incorporates a moulded lug secured to the door curtain, which interlocks with the matching shaped side-track. The design ensures smooth operation with exceptional wind load characteristics.

Independently Tested and Certified

Investigation and calculations for 'Ultimate Limit State Design' conducted by Technisearch Ltd., of Melbourne, Australia, showed the Steel-Line Windlok System, by Creeks, complied with Australian Standard AS1170.2-1989, Section 3, for Category C regions with wind speeds to 70 metres/second, subject to proper fixing of the bracket to an approved supporting structure.

Added Security

The Steel-Line Windlok Roller Door Guide Channel System not only holds the door firmly in position to help prevent damage caused by high winds, but it also serves as an extra safe-guard against 'break-ins', because the curtain cannot be easily pushed in to allow unwanted entry.

Installation

A major advantage of the Steel-Line Windlok System by Creeks is that it is as simple to install as a standard Steel-Line Roller Door. Some allowance for extra curtain width is necessary, and provided the support structure is adequate the fixing is quick and easy, using the height adjustable bracket system.

Economical and Versatile

The costs are minimal in comparison to the advantages gained when the Steel-Line Windlok System is included in a new installation.

Helpful Advice

Whether you're considering installing a new Steel-Line Roller Door and are not sure what you need, or wish to make your existing Roller Door more secure, contact a Steel-Line Roller Door Distributor who will gladly advise on all aspects of the Steel-Line Windlok System by Creeks.

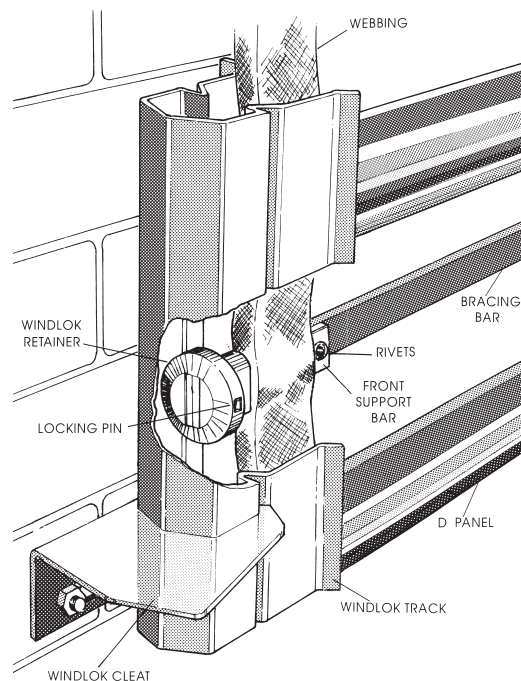

TOTAL GEOGRAPHIC COVERAGE

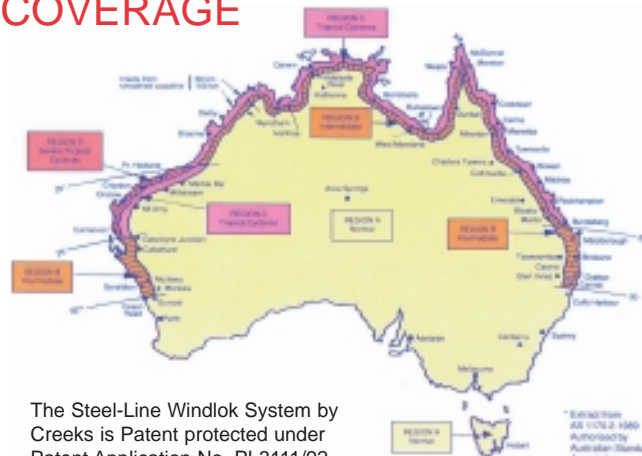

The Steel-Line Windlok System by Creeks is Patent protected under Patent Application No. PL3111/92

SUIT: SERIES A - AA & B
ROLLER DOORS

Windlok



Adore your door
STEEL-LINE
GARAGE DOORS

July 2006

Congratulations on your purchase of a Steel-line product.

Steel-line Garage Doors hereafter referred to as the Manufacturer hereby warrants:

1. Garage Doors (Domestic) to be free from defects in material and workmanship for a period of 3 years from date of purchase.
2. Garage Doors (Commercial Application) Light Industrial Doors plus Roller Shutters and Aluminium Type Doors to be free from defects in material and workmanship for a period of 1 year from date of purchase.
With the exception that:
 - (i) While Colorbond doors are long lasting, hardwearing, peel, flake and chip resistant, under normal conditions this warranty does not extend to inherent defects in steel or other material used in the manufacture or to the Colorbond process applied. The company will, however, procure and assign to the customer the benefit of the Warranty of the manufacturer BlueScope
 - (ii) From the date of purchase, providing that the installation was correctly performed and the appropriate care and services have been performed by the purchaser, the manufacturers obligations under the Warranty are limited to rectify any such defect in material and workmanship in a manner that is considered reasonable by the manufacturer and including if required, the use of touch up paint to the surface coat.
 - (iii) In the case of timber clad doors due to the nature of timber No warranty will apply to the timber component if affected by the weather.
3. Where the Garage Door has been installed by the manufacturer the warranty on such installation shall be free from defect in workmanship and material for a period of 1 year for domestic and 3 months for industrial and commercial applications from date of its installation.
4. Garage Door Operators (Domestic Application) to be free from defects in material for a period of 5 years for motors and 1 year for Electronics and Mechanics from date of purchase.
5. Garage Door Operators (Commercial Application) to be free from defects in material for a period of 3 months from date of purchase.
6. Where the Garage Door operator has been installed by the manufacturer, the warranty on such installations shall be free from defect in workmanship and material for a period of 1 year.
7. Where a unit has been returned to the Manufacturer, all costs incurred in the return will be paid for by the purchaser. If in the opinion of the Manufacturer the product is found to be faulty, all defective parts will be replaced at no cost to the purchaser.
 - (i) Where a defect is found in an operator which has been installed by the Manufacturer, the purchaser shall notify the Manufacturer and the Manufacturer shall make arrangements to inspect the said operator.
 - (ii) The Manufacturer retains the option to repair or replace any operator found to be faulty.
 - (iii) If during an on site inspection the fault is rectified by an adjustment that comes under the responsibility of the purchaser to have the product serviced on a regular basis, a service fee will be charged.
8. Proof of purchase must be given to the manufacturer at time of Warranty claim.
9. Clear access must be provided to drum, operator, track and lifting equipment to enable our representatives to conduct service/warranty work,
10. Any claim for damaged panel or curtain must be made within 7 days of supply, or installation.
11. The manufacturer reserves the right to modify any existing or future products without incurring any obligation to incorporate such modification to product already manufactured or to which this Warranty may relate.
12. The manufacturer reserves the right to touch up on site Colorbond and or Pre-Painted surfaces on its range of garage doors but no responsibility will be taken for the possibility of any paint rubs, scuffing etc on the internal wash coat finish or external painted surface.
13. This Warranty does not apply to any defect, loss or damage arising or caused directly or indirectly by or as a result of:
 - (i) Any masonry rendered or other surfaces cracking or collapsing during installation of the door.
 - (ii) Any defect or deterioration of timber including drying out after installation.
 - (iii) Any weakening or collapse of the structure to which the doors are affixed occurring any time after installation
 - (iv) Any damage to or deterioration in the condition of the doors occurring after delivery and prior to installation
 - (v) Any defect (including defects in component parts or accessories) arising from or attributable to the failure to carry out normal preventive maintenance or adjustment.
 - (vi) To any additional defect damage or deterioration arising from or attributable to the operation of the door after it is known to be defective.
 - (vii) To any door being installed within 800 metres of the sea or other body of water of equivalent or greater salt concentration or in an area subject to industrial fall out or the use of incorrect cleaning material (acid wash) on the door or adjacent area.
14. Exclusions to Warranty Period:
 - (i) Key & Barrell - 1 Year Warranty
 - (ii) Spring Tensions - 3 Months Warranty
 - (iii) Repair or Warranty Work - 3 Months Warranty
15. Not included in Warranty (Garage Doors Operators):
 - (i) Batteries
 - (ii) Fuses
 - (iii) Globes
 - (iv) Sensitivity and Limit Switch adjustment
 - (v) Transmitter and Receiver Range
 - (vi) or misuse of product
16. Note: All Warranties will be voided subject to:
 - (i) Water damage and condensation
 - (ii) Power supply black out or surge
 - (iii) Door blowing in, storm damage or any act of God
 - (iv) Modification or Adjustment by unauthorised persons.
 - (v) Any interference from radio (including citizen band radios) or any other electronic device.
 - (vi) Account not paid in full by the purchaser.
 - (vii) Preventive maintenance and regular servicing by experienced door installers.
17. Subject only to the provisions of the Trade Practices Act and any legislation of the State or Territory wherein the doors of the Company shall have been sold or installed (which may confer certain rights on consumers of goods and those rights by such legislation may be rendered incapable of exclusion) this warranty supersedes and excludes all representations, warranties and conditions whether expressed or implied by law and the Company shall have no liability or otherwise that herein provided for any loss and damage (including consequential loss and damage, loss of use or profits) by reasons of delay, defective or faulty materials or workmanship, negligence or any act, matter or thing done permitted or omitted to be done by the Company.



Adore your door
STEEL-LINE

GARAGE DOORS

ACN 124 164 003 ABN 52 124 164 003
<http://www.steel-line.com.au>

THE LARGEST PRIVATELY OWNED GARAGE DOOR COMPANY IN AUSTRALIA



BRISBANE Head Office
MANUFACTURING & SALES

Commitment is Our Strength

The underlying philosophy of Steel-Line is providing quality products and services which is achieved currently through a network of branches and distributors across the nation.

Display and Information Centres

Steel-Line display centres provide an interactive product display of the door industries latest innovations.

An Extensive Branch Network

Steel-Line's expanding national network of fully owned and operated branches provide the solutions to your garage door and remote control requirements

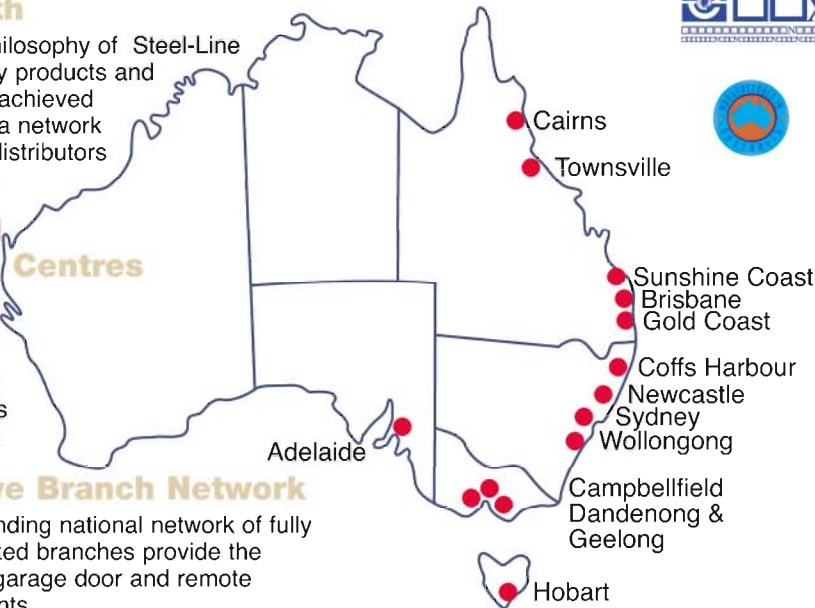

- **BRISBANE Head Office**
51 Perivale Street,
Darra, Qld 4076
Fax (07) 3376 4597
Phone (07) 3717 6666
BSA 725178
- **Dandenong South**
15 Mickie Street,
Dandenong South, Vic 3175
Fax (03) 9706 6552
Phone (03) 9706 6551
- **Geelong**
153 Weddell Street,
North Geelong, Vic 3215
Fax (03) 5277 1293
Phone (03) 5272 2346
- **Coffs Harbour**
24 Craft Close,
Boambee, NSW 2452
Fax (02) 6658 2667
Phone (02) 6658 2666
FT 11929C
- **Newcastle**
46-48 Orlando Road,
Lambton, NSW 2299
Fax (02) 4957 7344
Phone (02) 4957 7322
FT 11929C
- **Sydney**
Unit 1/3-5 Wrightland Place,
Off Doonside Road,
Arndell Park, NSW 2148
Fax (02) 9679 5222
Phone (02) 9679 5200
FT 11929C
- **Wollongong**
8 Lady Penrhyn Drive,
Unanderra, NSW 2526
Fax (02) 4272 4591
Phone (02) 4272 4587
FT 11929C
- **Hobart**
31 Coleman Street,
Moonah, Tas 7009
Fax (03) 6273 5989
Phone (03) 6273 5988
- **Adelaide**
503 Cross Keys Road,
Cavan, SA 5094
Fax (08) 8359 1200
Phone (08) 8359 1133
BL 174026
- **Campbellfield**
111 National Boulevard,
Campbellfield, Vic 3061
Fax (03) 9300 7888
Phone (03) 9300 7800
- **Sunshine Coast**
8 Flagstone Drive,
Andrews, Qld 4220
Fax (07) 5576 6228
Phone (07) 5576 6222
BSA 725178
- **Townsville**
38-40 Crocodile Cres,
Mt St John, Qld 4811
Fax (07) 4774 6822
Phone (07) 4774 6811
BSA 725178
- **Gold Coast**
8 Flagstone Drive,
Andrews, Qld 4220
Fax (07) 5576 6228
Phone (07) 5576 6222
BSA 725178

Distributor

